

電池  
串聯

一條線

串聯  
要在同一個線上

燈泡並聯

在一起較亮  
並聯分開較暗

燈泡至少要有2顆



燈

電池並聯

電池串聯

電池並聯

電池串聯

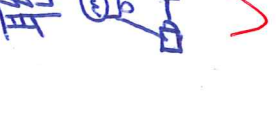

電池

串聯看電池

並聯看電池

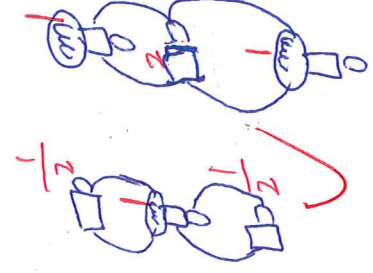
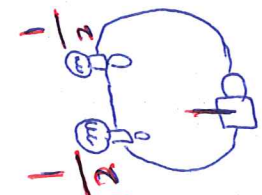
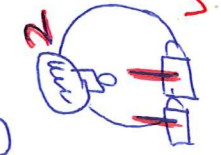
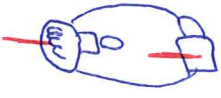

f16

燈泡

(2)

蘇州 4222  
某四乙

✓ 並聯

燈泡

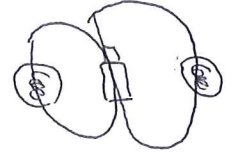

✓ 串聯

燈泡

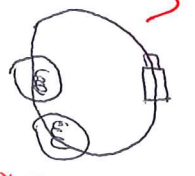

2

串聯看電池

電池

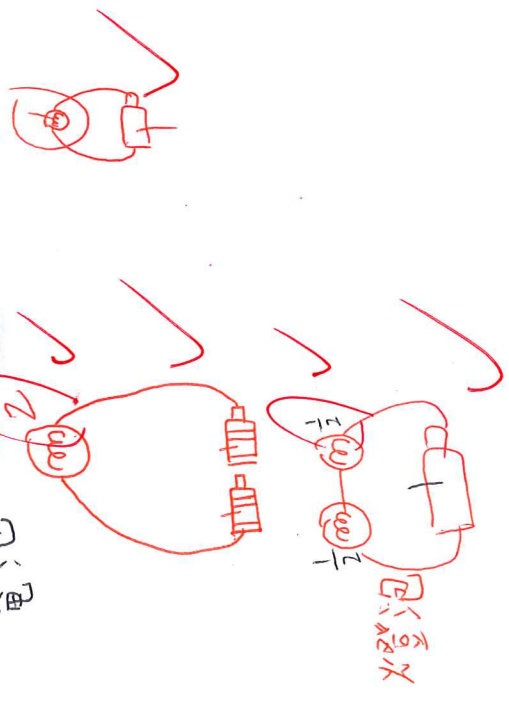

✓ 並聯

電池看燈泡

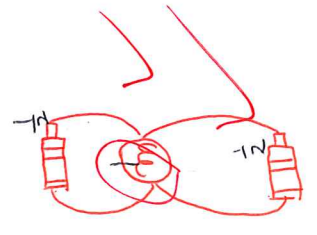

燈泡

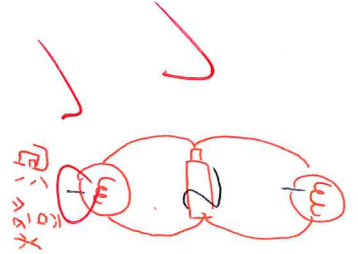

3

4

515

②

4209

兩條線

看燈炮



燈炮並聯

並聯

分開

比較日

一條線

串聯



在一起

比較亮

要在同條線上

看電池

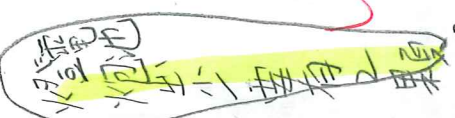

燈炮並聯

燈炮串聯

電池串聯

電池並聯

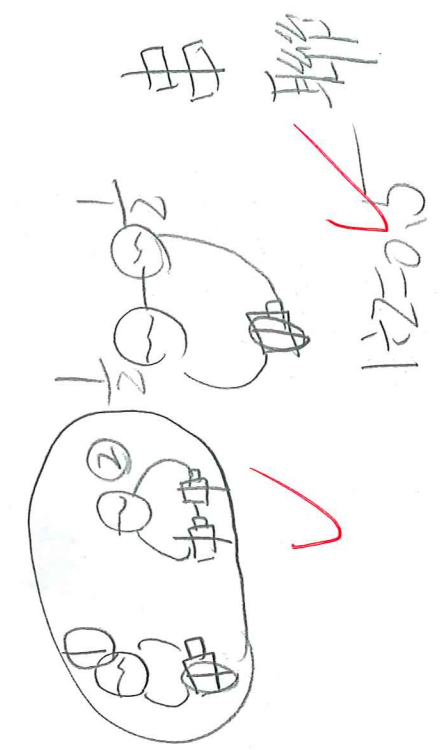
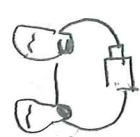

並聯

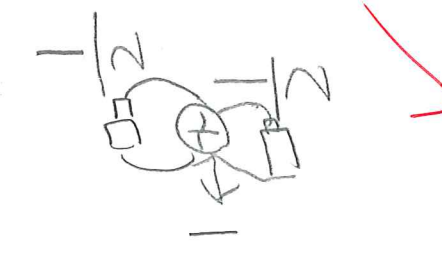

+14

②

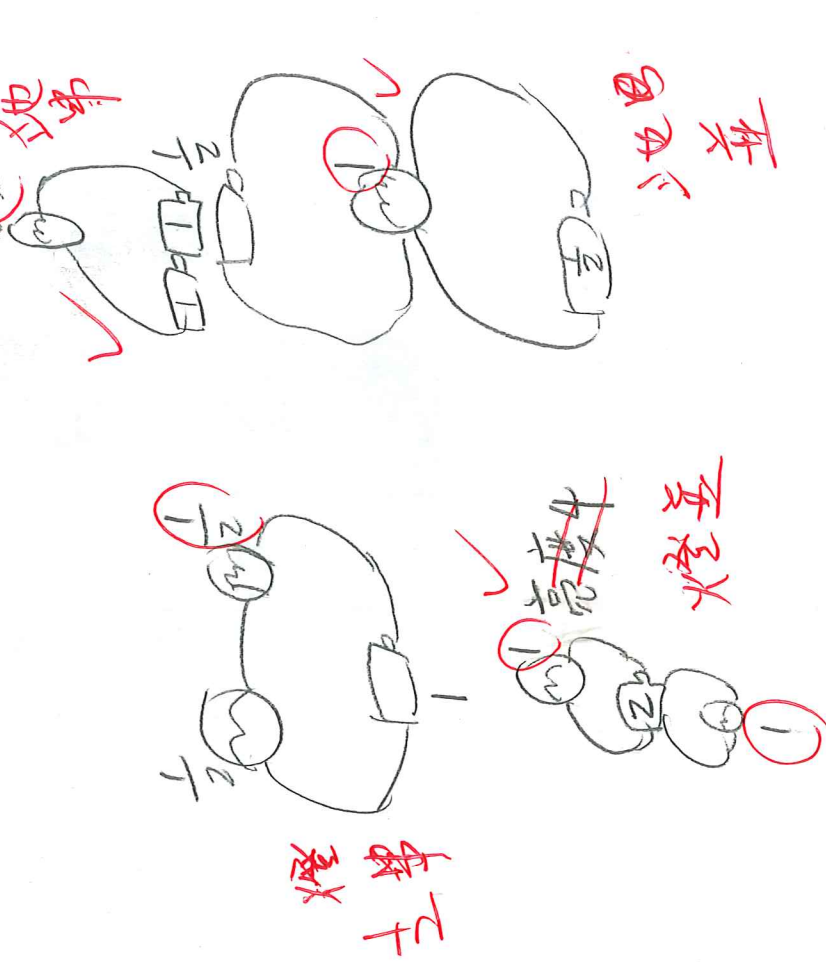
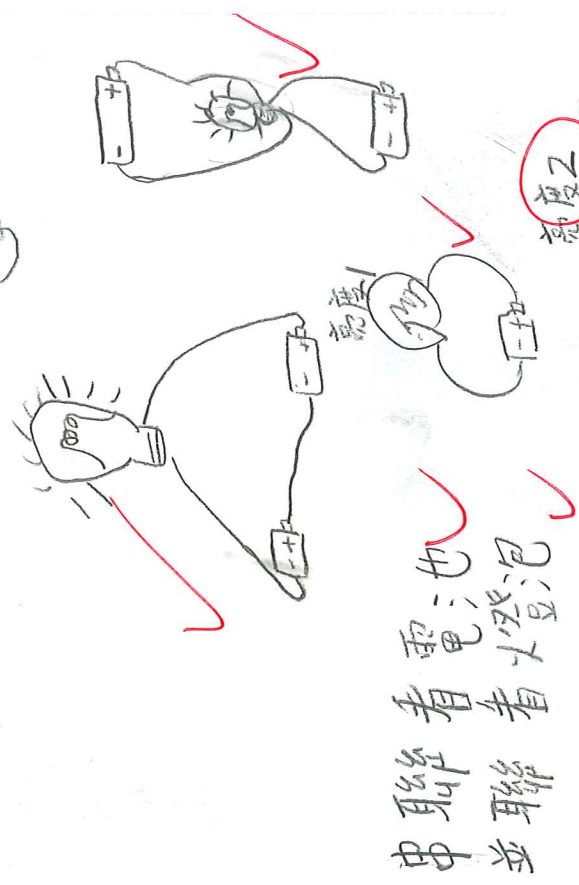
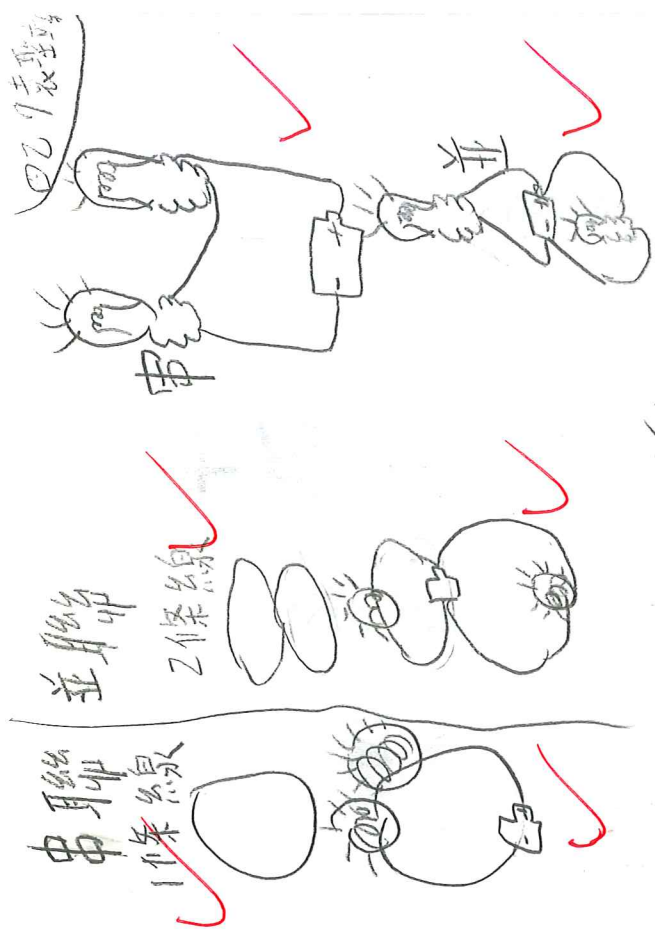

f14

(2)

① 串聯

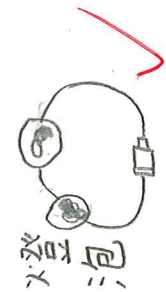

② 並聯

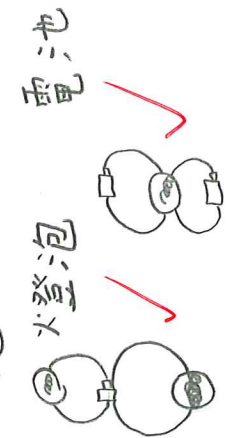

① 串聯 ~~比~~ 並聯 比較亮

② 並聯 ~~比~~ 串聯 比較亮 一樣

① 串聯看電池

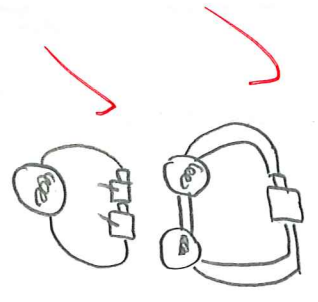

② 並聯看火燈泡

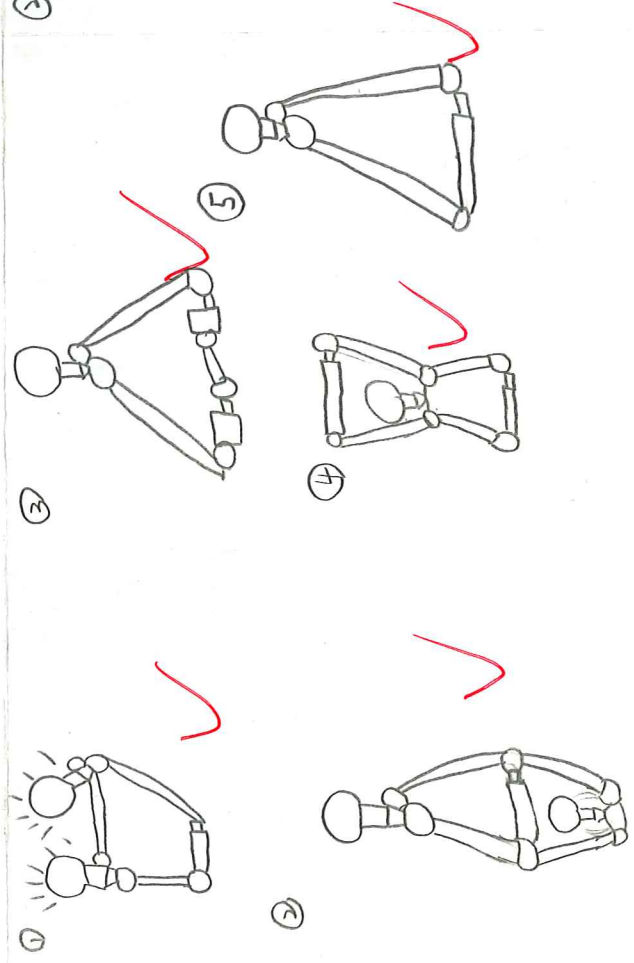

+13

②

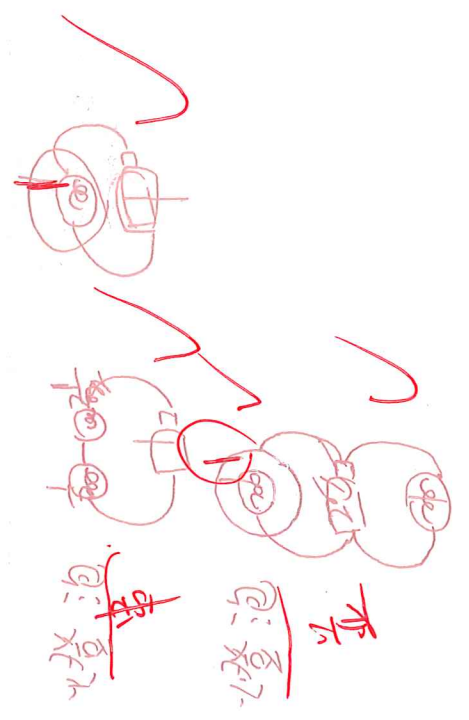
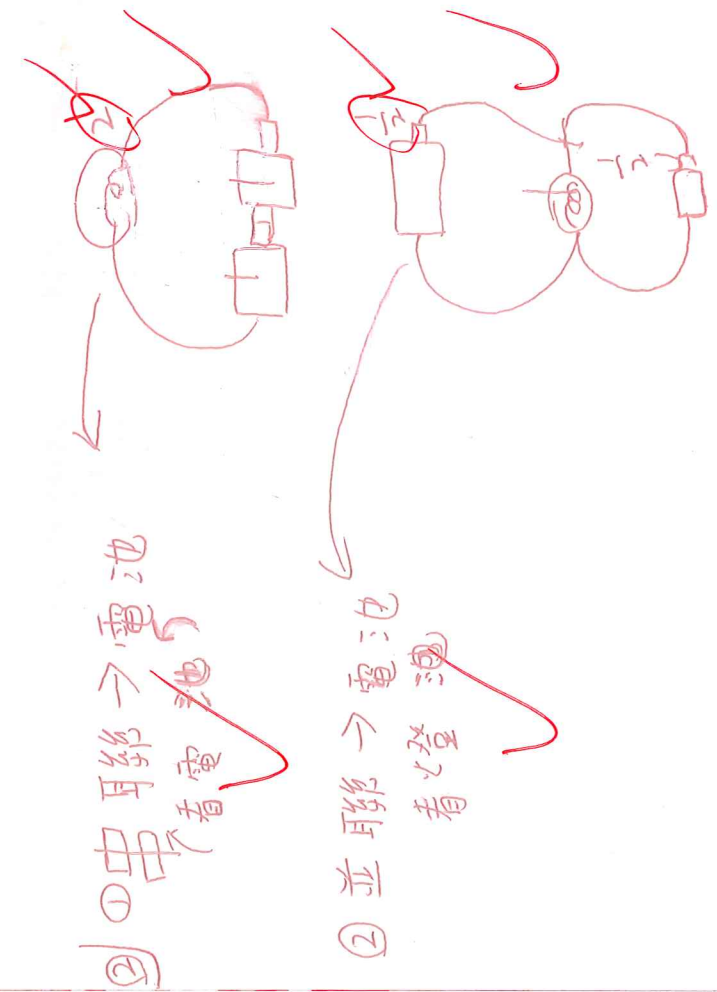
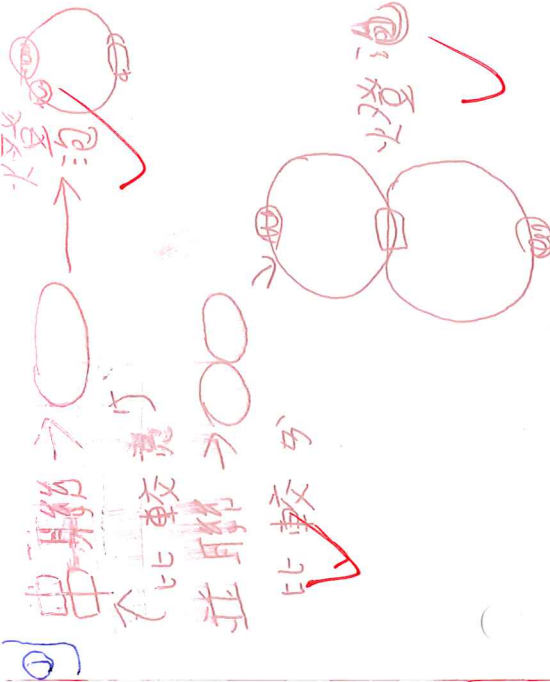

413

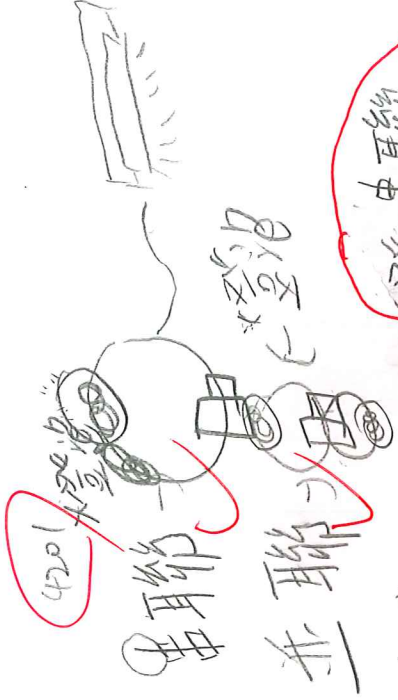

串要在一條線上

串 並  
在一起

在一起

燈泡並聯比較亮

燈泡並聯比較暗

燈泡並聯

兩電池

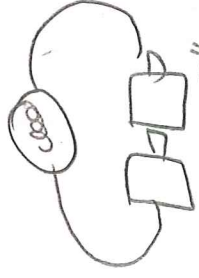
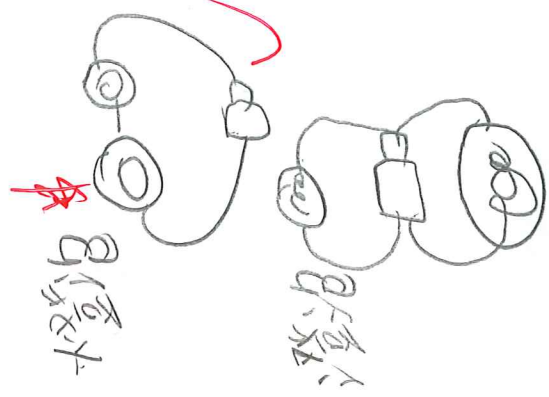

兩電池串聯  
兩電池並聯



12=05

兩電池

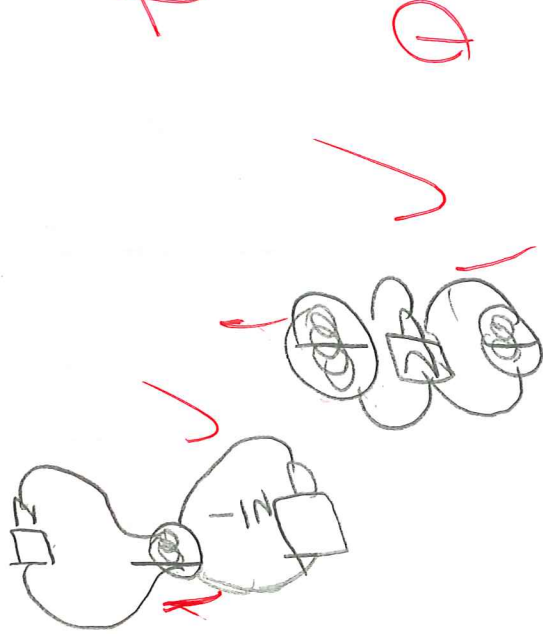
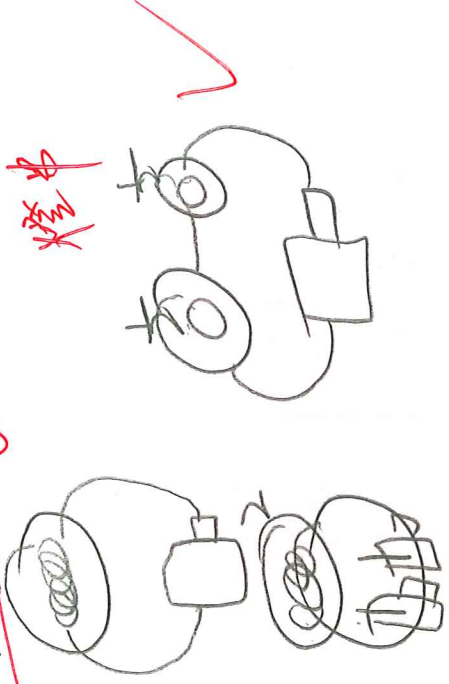

17 謝陽芳

串聯 → 比車燈  
並聯 → 比較暗  
一樣

電池  
串聯 → 電池  
並聯 → 電池  
看燈泡

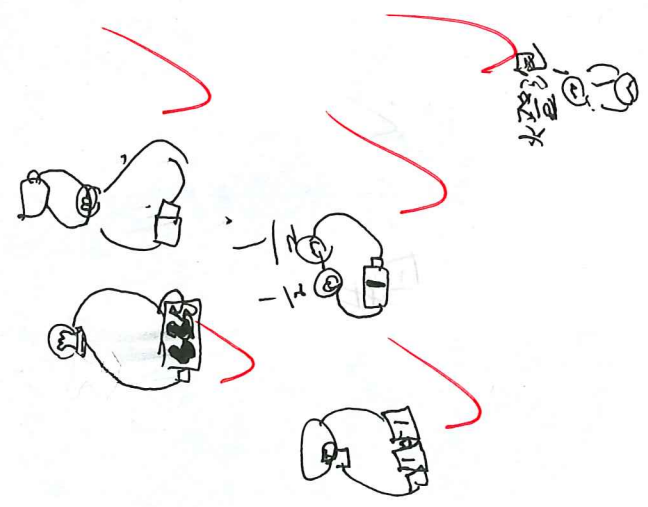

111+

①



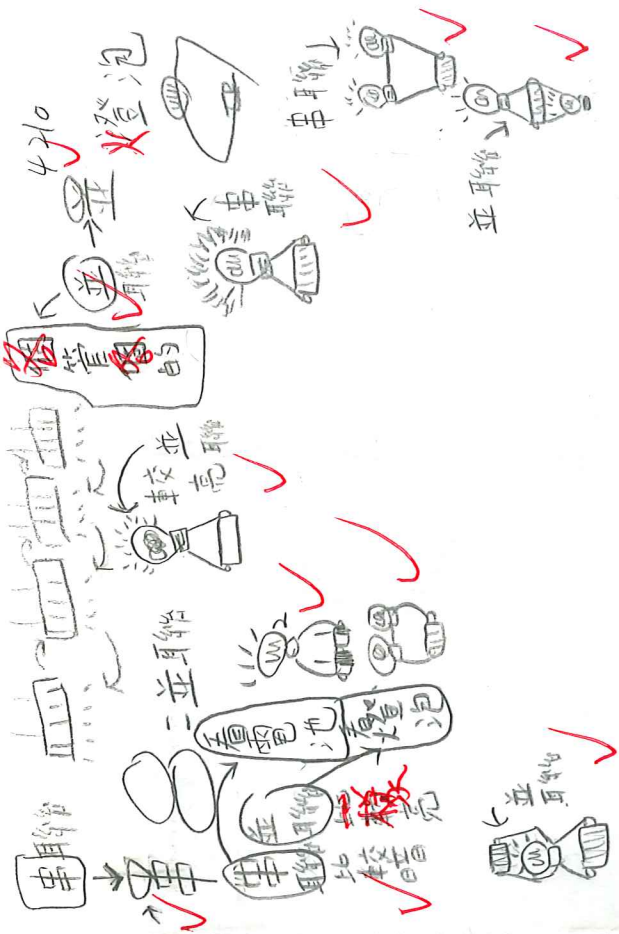

+11

①

串聯 = 連接

並聯 = 分開

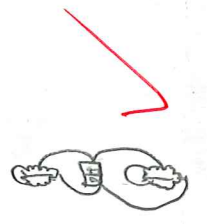
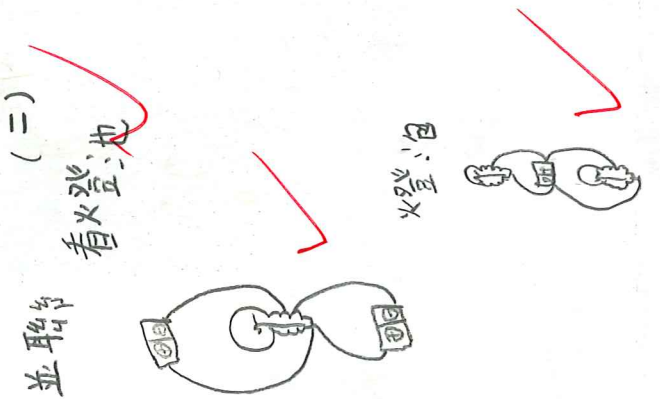
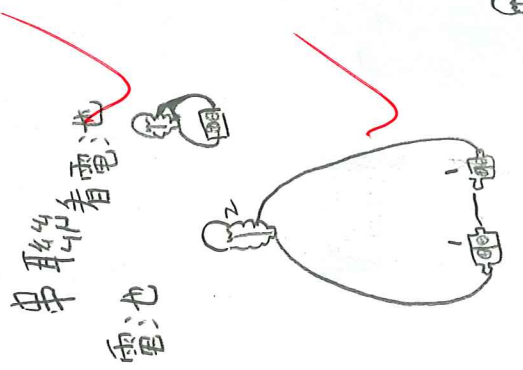
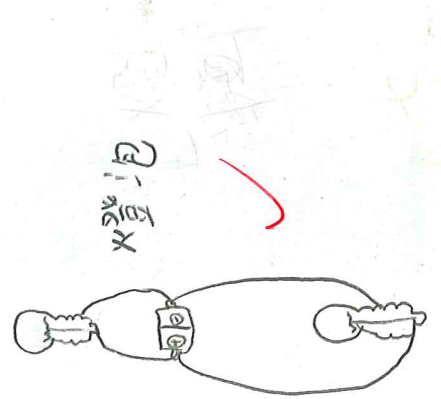
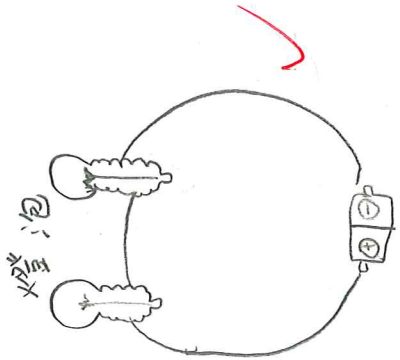

f10

①

017

①

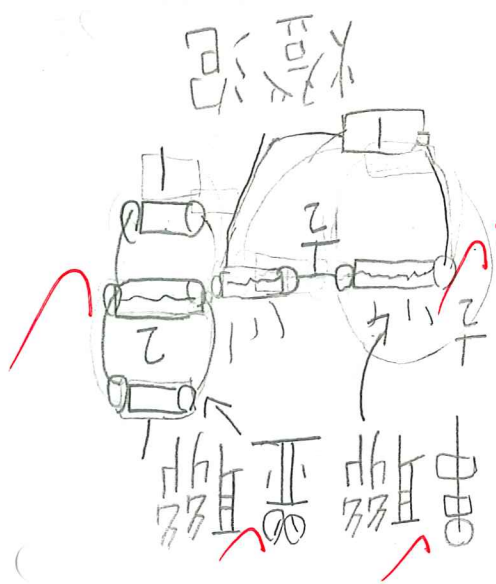
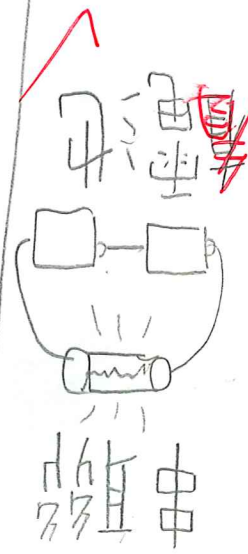
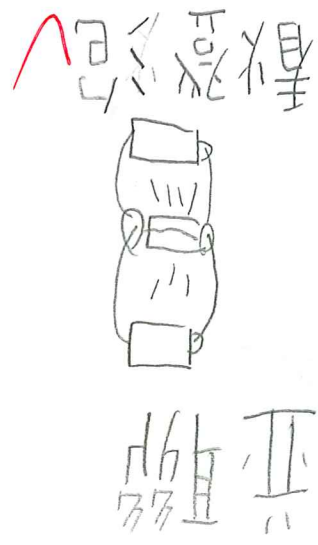
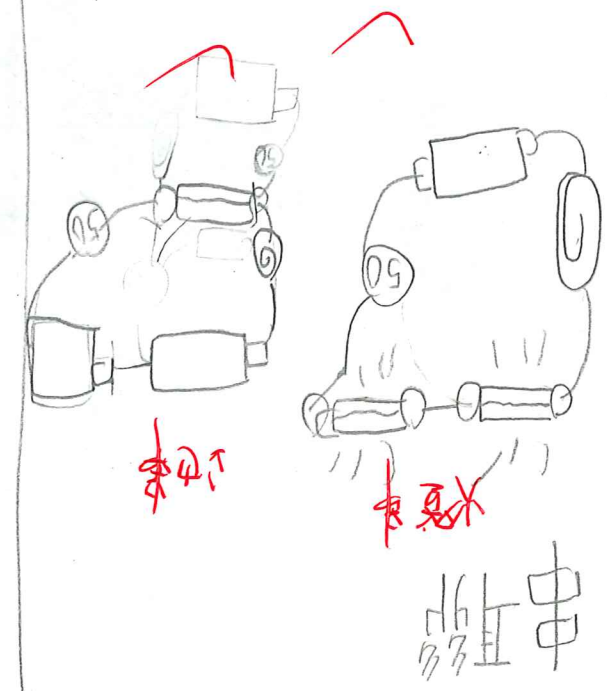
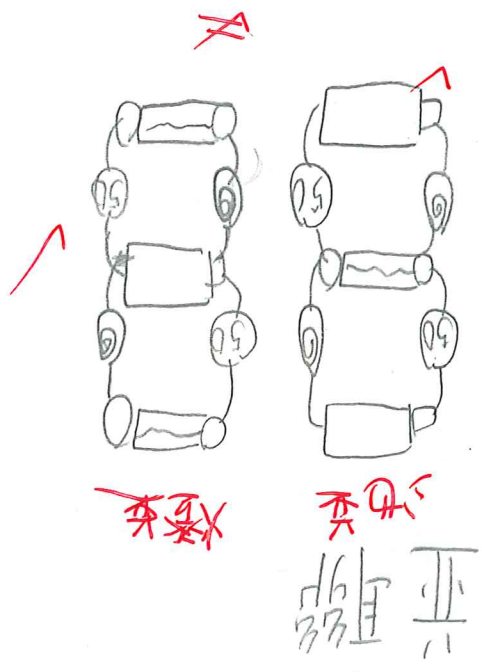

4203

串聯連接  
並聯分路

(一)

燈泡

(二)

燈泡串聯比較暗

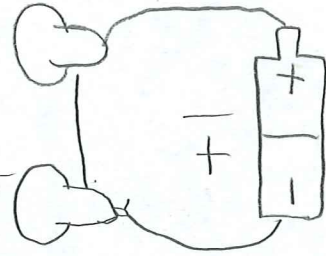

同一條路

(三)

燈泡並聯一樣亮

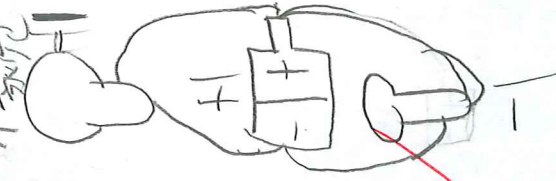

不同的路

→

電池串聯比較亮

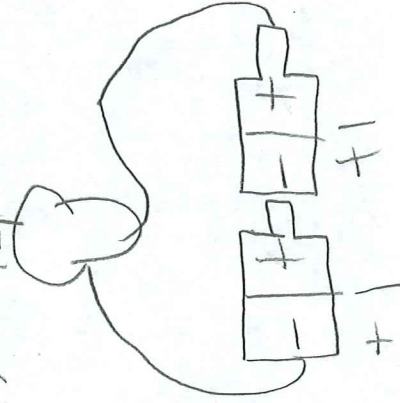

同一條路

電池並聯一樣亮

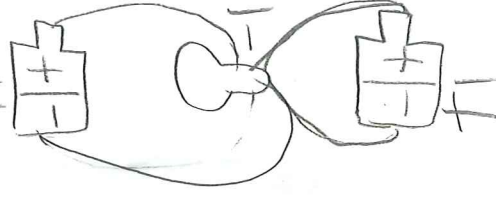

不同的路

①

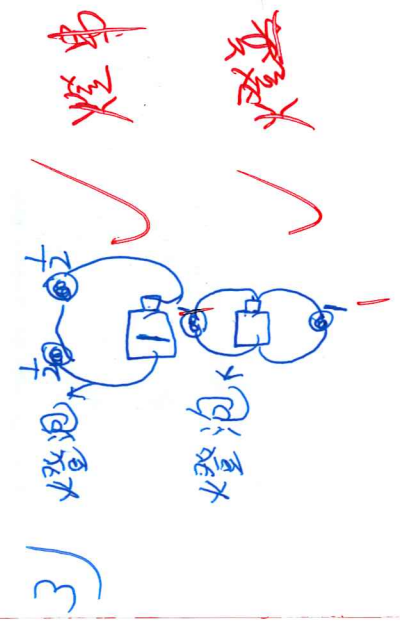
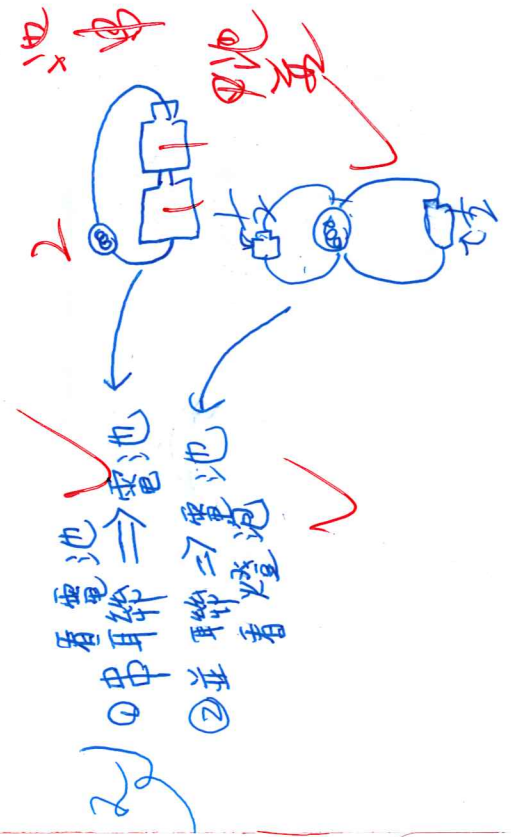
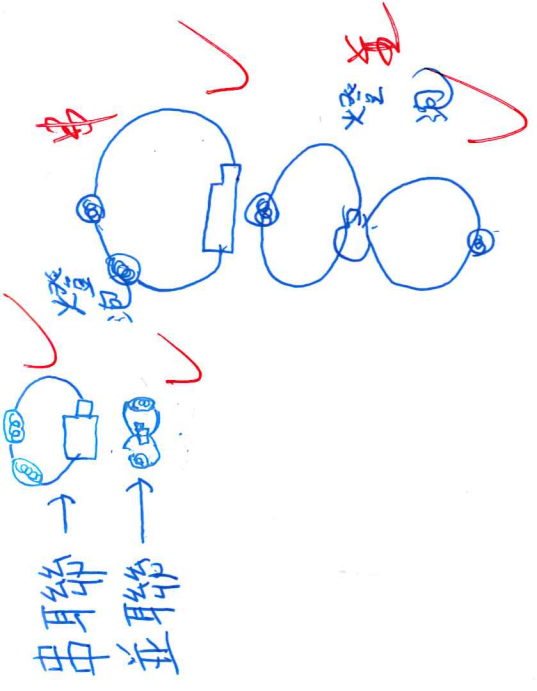

+

4213

串联

并联

灯泡

电池

串联者电池

并联者灯泡

池并

池串

串联

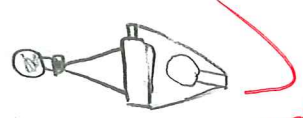
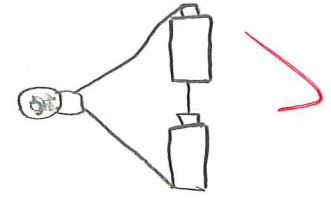
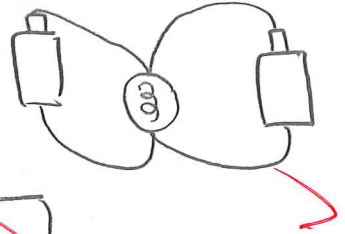
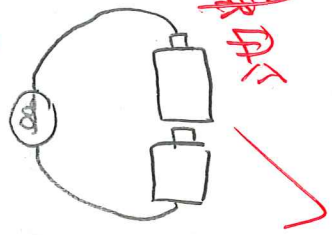
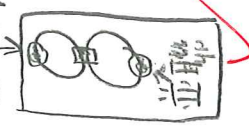
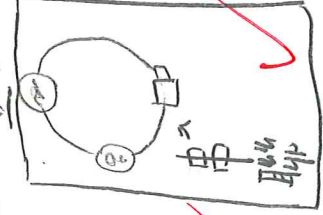

49

①

① 串聯 = 連接  
 ② 並聯 = 分開

看燈泡

100-100

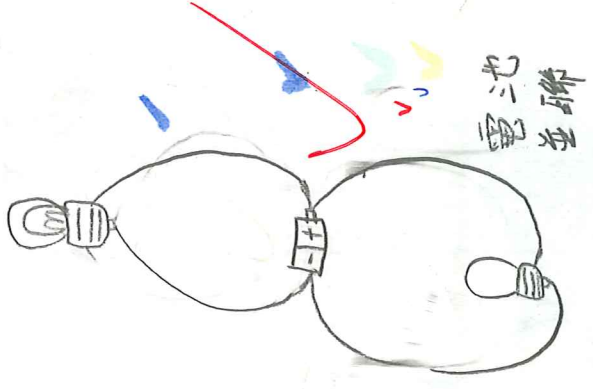

電池  
並聯

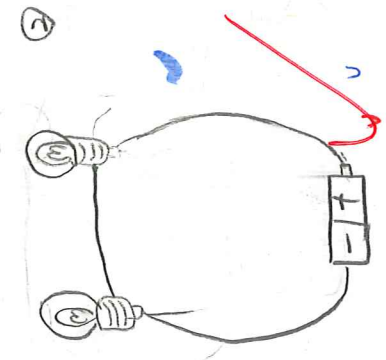
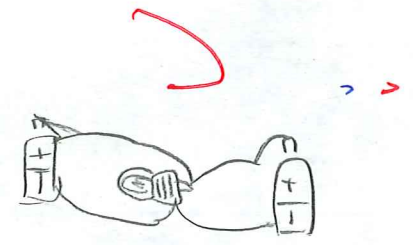

電池  
串聯

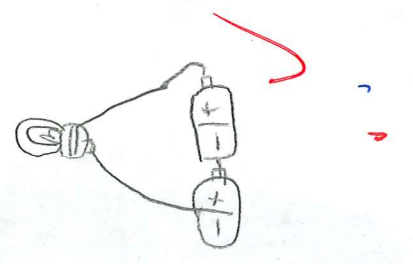

78

①

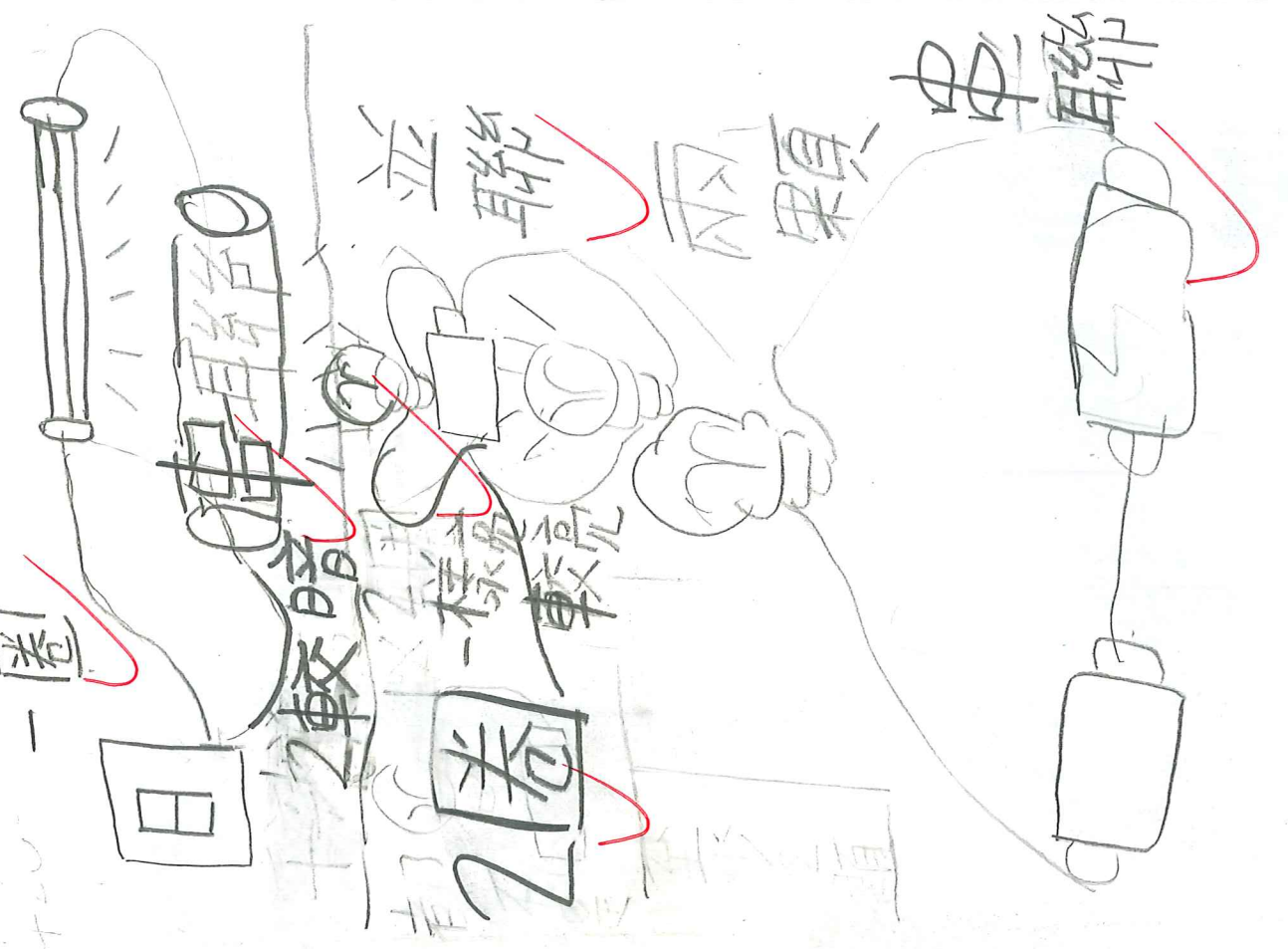
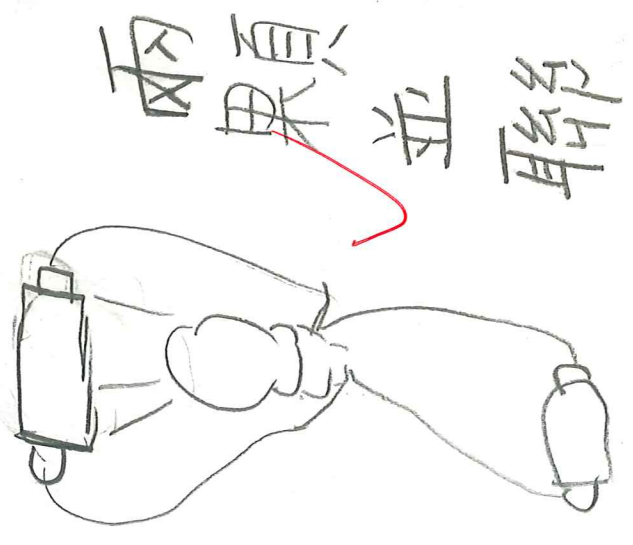

Handwritten scribbles and faint markings.

Handwritten red markings, possibly a signature or initials.



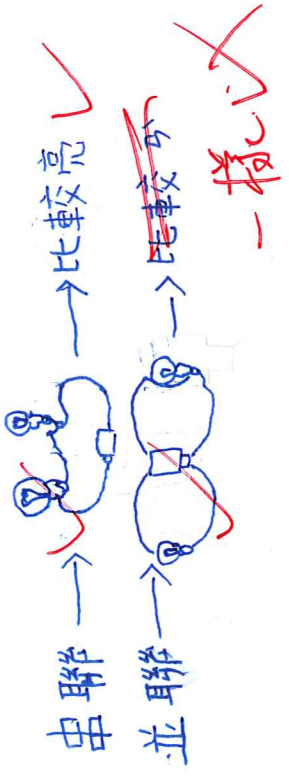

串聯 電池

較亮 ✓

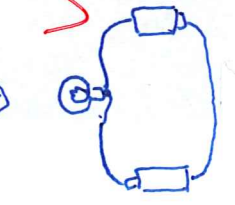

並聯 電池

一樣亮 ✓

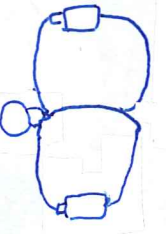

並聯看燈泡 ✓



串聯看電池 ✓

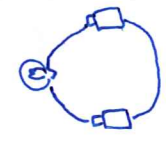

+

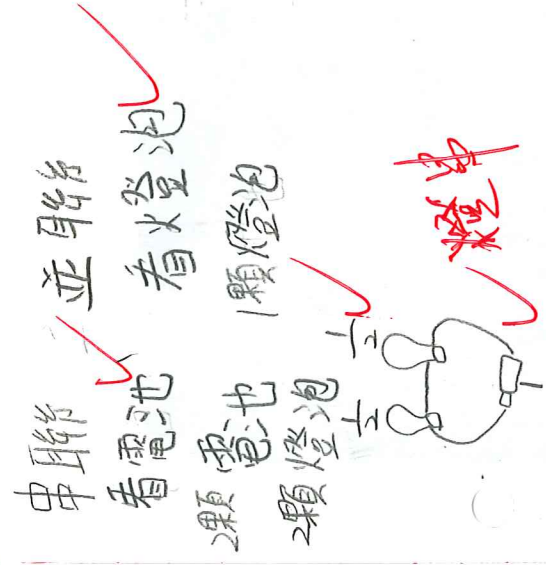
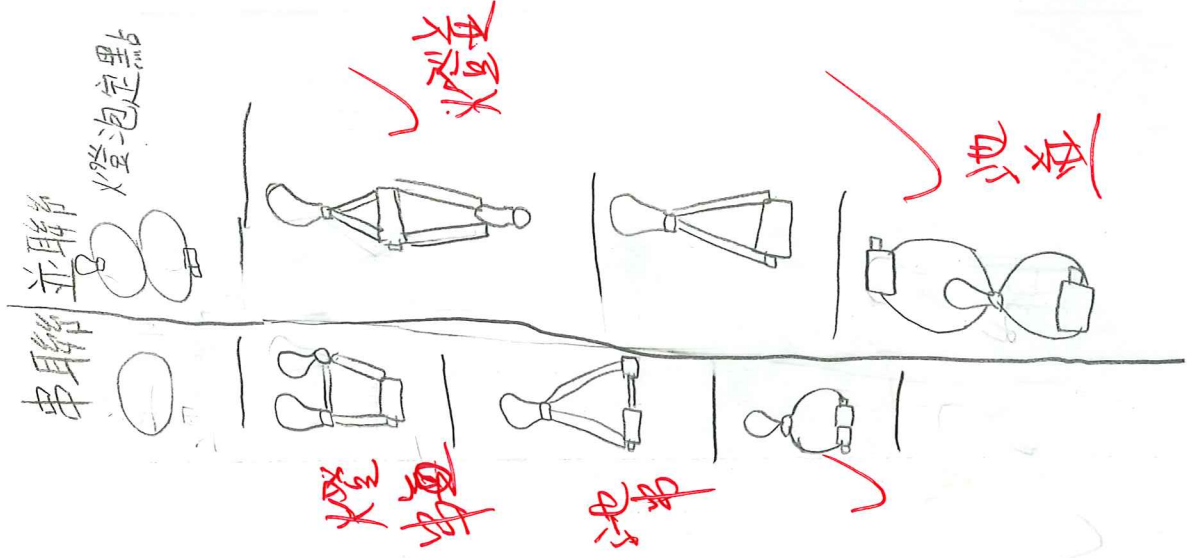

1. 串

2. 池

3. 燈

4. 串

6 神符水

串耳耳 水豆泡

世

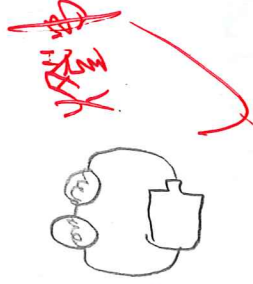
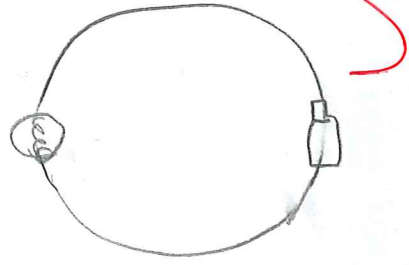

水豆泡

串耳耳 世 水豆泡

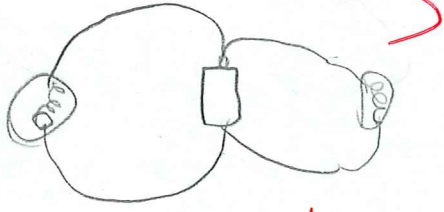

水豆泡

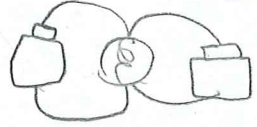

水豆泡

世

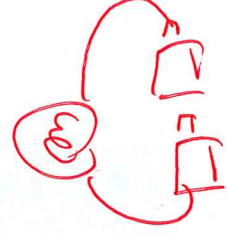

世

9 + 6

42A4

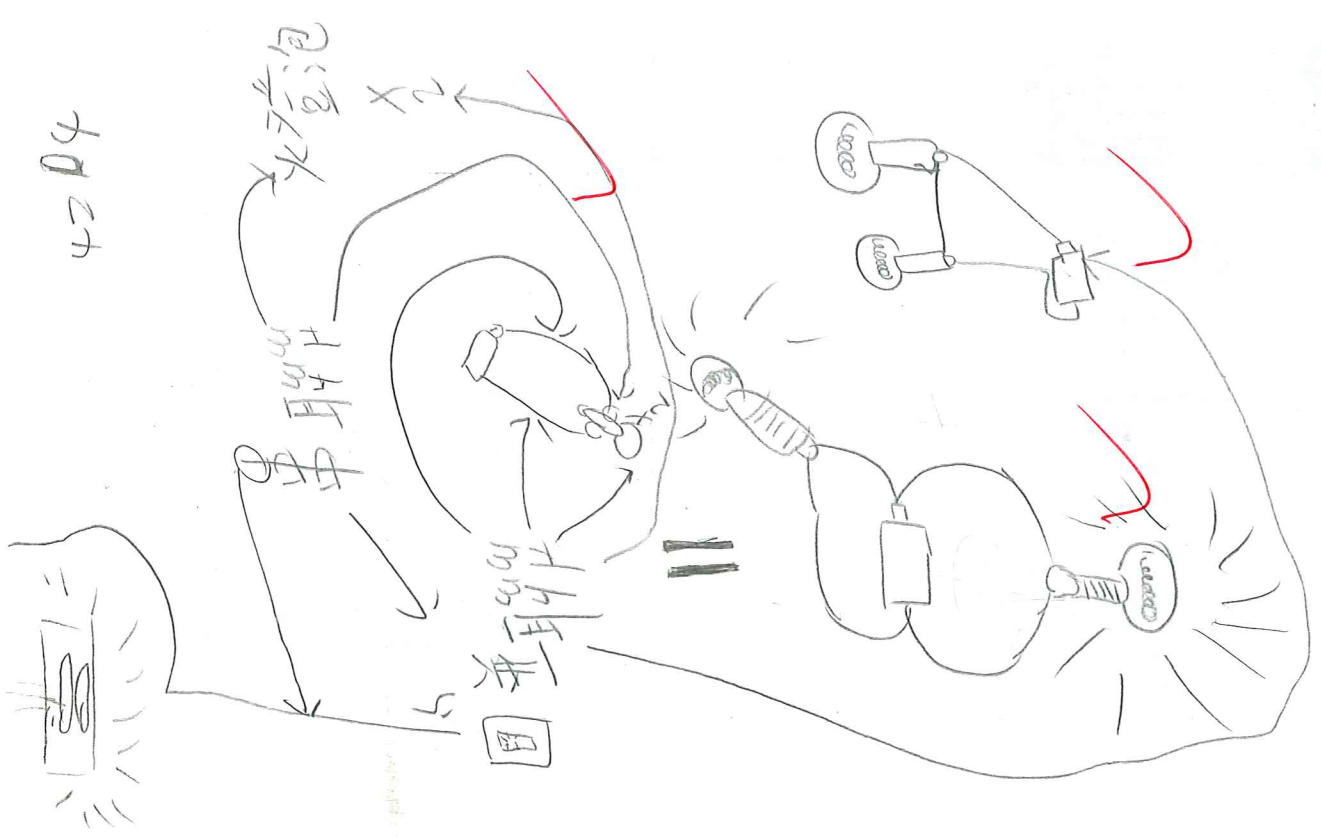

電池

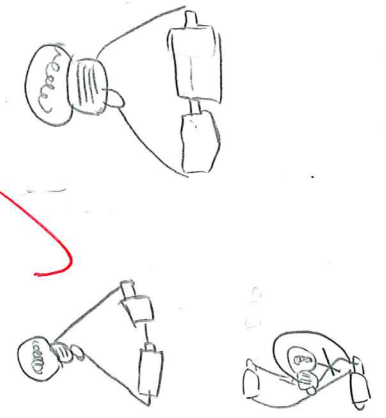

44